

Highest quality  
**TIMBER  
WINDOWS  
AND  
DOORS**







## ABOUT US

We are manufacturer of wide range timber windows and doors, based in Vilnius, Lithuania. We export over 90% of our products to England since 2011. We have earned a reputation for our high quality products and our integrity in dealing with clients and also in being the most responsive, client focused partner in the industry.

Langvalda serves everyone from constructors to private homeowners creating design and engineer solutions to every building.

From design to installation we can work together to fulfil the most unusual ideas. Offering an extensive collection of windows and doors designs, specifically tailored to suit all tastes, we pride ourselves on offering the most innovative, visually appealing and technologically advanced product range; all designed to help you discover the perfect product at a price that suits you.

**Our qualified engineers can make Your ideas come to life and create spectacular windows and doors in whatever design You fancy.**



## WOOD

**One of the key factories ensuring the highest quality is wood and how wood is processed. Our windows are produced using laminated wood beams in the Nordic pine and oak. Other type of wood such as Mahogany, Sapele and Siberian larch can be both: solid and glued beams. All wood which we are using has FSC certification. It means that wood are from forest that are 100% replanted.**



### WOOD TYPES:

**NORDIC PINE** - is from slow-grown northern forest (Siberia, Karelia). Wood is soft, medium in weight, has medium density and also has excellent fiber and characteristics: tight growth rings, resulting natural strength. The heartwood is naturally resistant to decay and can also withstand attacks by insects.

**OAK** - The quality of oak is truly remarkable. Oak wood has a density of about 0.75 g/cm creating great strength and hardness. It is very resistant to insect and fungal attack, also it is durable even in contact with moisture beyond all common belief. Oak is characterized as durable, long lasting with a bright and strong wood texture.

**SAPELE** - is hard and very durable hardwood. Solid Sapele is generally stable when dry, making it ideal for use in doors and windows. It is ideal for painted applications due to its fine graining. Sapele also has the attractive aroma resistant to insects.

**SIBERIAN LARCH:** siberian larch timber is naturally beautiful - thats why no finishing required. This tree is one of the best coniferous woods in the forest, with excellent properties:

- Much lower moisture absorption levels compared with fir.
- Impregnation unnecessary.
- High durability and very resistant to rot and fungus.
- High mechanical resistance and very good pressure resistance.
- Excellent wear resistance (Class II).
- High density.
- Aesthetically pleasing to the eye; warm colours from golden brown to yellow sand, orange in the heartwood.





## GLAZING

Sash windows are glazed with double-glazed units which incorporate an advanced thermally insulating glass to provide extremely low U-values. The efficiency is further improved by filling cavity with Argon Gas and low conductivity WARM EDGE SPACER bars to minimize heat loss on the edges and result in centre pane U-values of 1.0 W/m.

High light transmittance (75%+) maximizes the entry of sun light into your home. As well as our range of clear glass options, we also have a wide choice of etched glass and extensive obscure patterned glass available in any of our windows.

**TOUGHENED GLASS** – for strenght and breakage-resistance, temper glasses often is the first consideration.

Toughened laminated glass is four to five times stronger than standard float glass of the same thickness. This type of tempered glass offers high performance and strength under extreme pressures and is less prone to breakage.

**LAMINATED GLASS** – For flexibility, UV-resistance, security and sound considerations, laminated glass is often the product of choice. It provides additional security over toughened unit. When smashed, laminated glass holds in place and does not break up into hundreds of little pieces. Instead, it keeps in place long enough for a replacement to be found. Typically, laminated glass products are slightly higher price than tempered products of the same type and thickness.

**OBSCURE GLASS** – gives privacy and style to windows. Obscure glass ranges from offering very slight distortion to completely hiding the items in question from view or revealing only silhouettes.  
\*available in a wide range of patterns.

To improve security, all our windows are glazed internally which makes it impossible for intruders to gain entry by removing the glass. All double glazed units are designed with drainage and ventilation channels which helps to prevent timber frame from humidity using condensation grooves.



# WINDOWS

Traditional Sash Box | Traditional Sash Spring  
Casement Window | Fixed Frame



# TRADITIONAL SASH BOX



The box-sash window is mainly a British commodity that is most found on Georgian and Victorian households.

However, more recently it has been frequently used on more modern houses to create a classic look.



Langvalda sash box windows are constructed to deliver the highest standards of insulation, security and longevity.

It is made with pulleys and weights to control the opening. Traditional sash boxes are the most suitable for traditional British houses.

Traditional Box Sash Windows are made-to measure. Windows are made out of engineered wood and supplied fully factory glazed and spray painted with top coat. The products are finished with top quality sash fasteners, lifts and pulleys.

## Traditional Sash Box frame

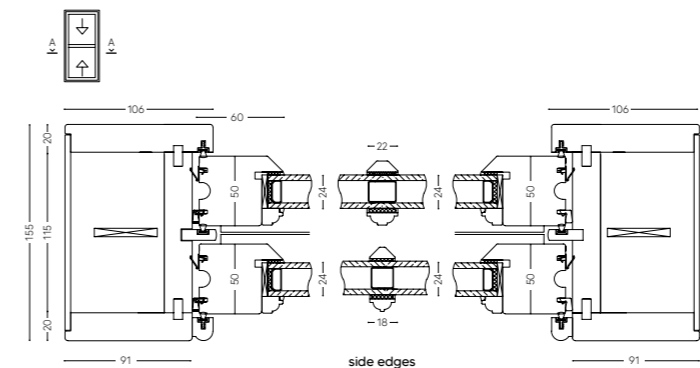
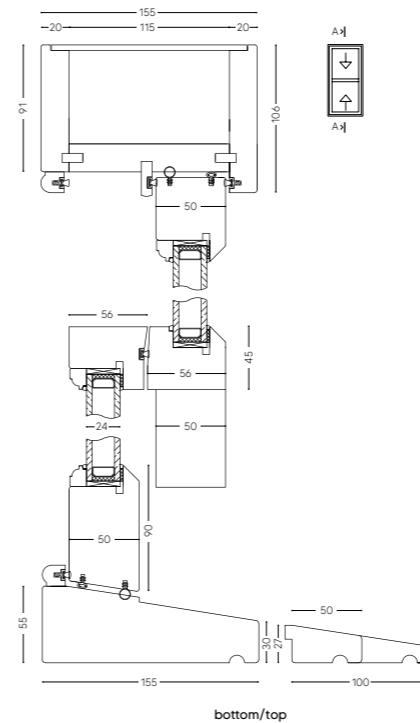

## Equipment of window

### Standard

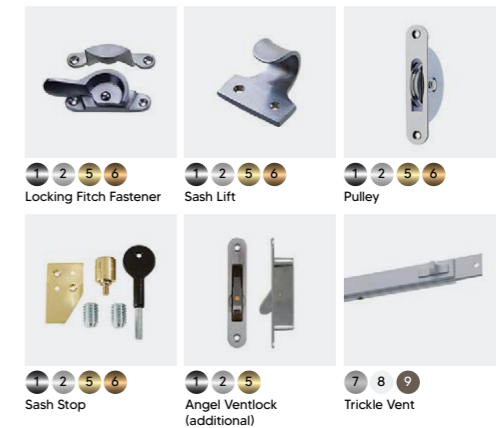

- Colors:  
 1 - Polished Chrome  
 2 - Satin Chrome  
 5 - Polished Brass  
 6 - Antique Brass  
 7 - Aluminium  
 8 - White  
 9 - Brown

- Min. size of the window 600x800mm
- Max. size of the window 1500x3000mm

# TRADITIONAL SASH SPRING



Spring sash windows are designed for a British homes, following all the traditions and customs. It can be made with any wood and color you wish, any size and hardware style you need.



Spring sash windows are modern alternative to box sash windows. It uses balance springs instead of weights and pulleys. Spring sash windows are being used in a traditional and modern houses, where the structure can't accommodate the rebate of the traditional box sash window. It is the best choice to connect these two, from the first sight incompatible things- traditions and modern technologies. Spring sash window looks like traditional box window, just have slimmer frame and sightlines - making glass area larger, letting more sunlight into the building.

## Traditional Sash Spring frame

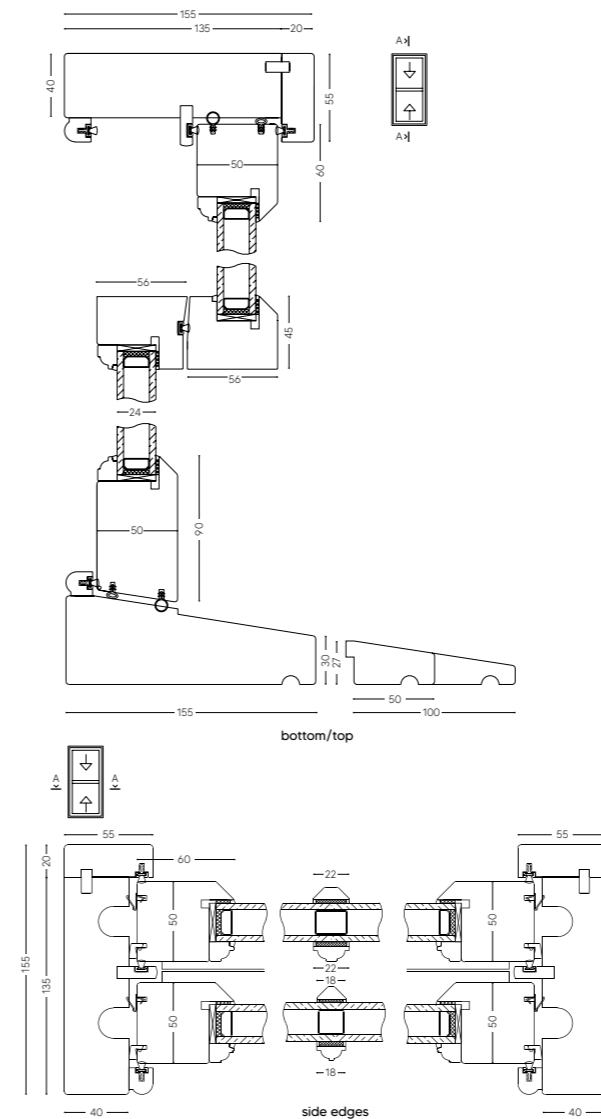

## Equipment of window

### Standard

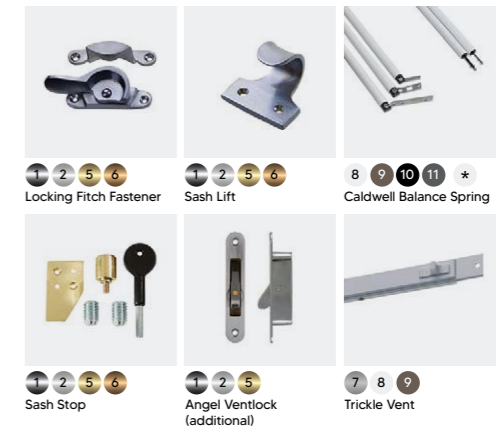

- Colors:
- 1 - Polished Chrome
  - 2 - Satin Chrome
  - 5 - Polished Brass
  - 6 - Antique Brass
  - 7 - Aluminium
  - 8 - White
  - 9 - Brown
  - 10 - Black
  - 11 - Grey
  - \* - custom RAL color

- Min. size of the window 400x350mm
- Max. size of the window 800x2000mm



# CASEMENT WINDOW



This classic yet modern design of casement window is a perfect addition to properties both old and new.

Clean, unfussy appearance is simple in looks and use. A casement window has a casement sash attached to a timber frame by hinges on one side and opens outwards or inwards. Casements are usually hinged at the side but they can be hinged at the top or the bottom of the window. Because of their draught sealing system, casements are air tight when closed which means they have very low air leakage rates.

## Casement Window frame

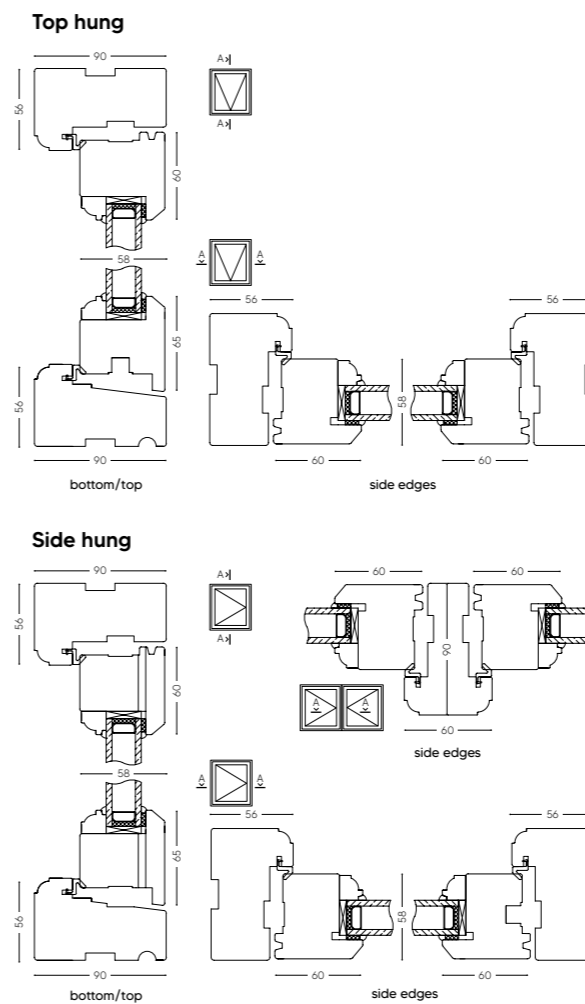

## Equipment of window

### Standard

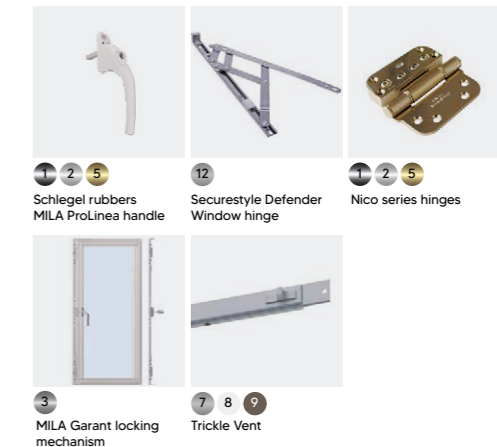

### Additional

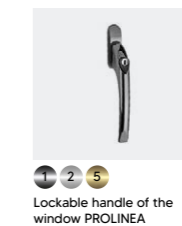

Colors:  
 1 - Polished Chrome  
 2 - Satin Chrome  
 3 - Matt Chrome  
 5 - Polished Brass  
 7 - Aluminium  
 8 - White  
 9 - Brown  
 12 - Steel

- Sash weight up to 40kg (Side Hung)
- Sash weight up to 50kg (Top Hung)
- Min. size of window 400x300mm (Top Hung)
- Max. size of window 1600x1500mm (Top Hung)
- Min. size of window 400x400mm (Side Hung)
- Max. size of window 1000x2300mm (Side Hung)



# FIXED FRAME

Window that cannot be opened. LANGVALDA can make window in several parts, with several glass panes.

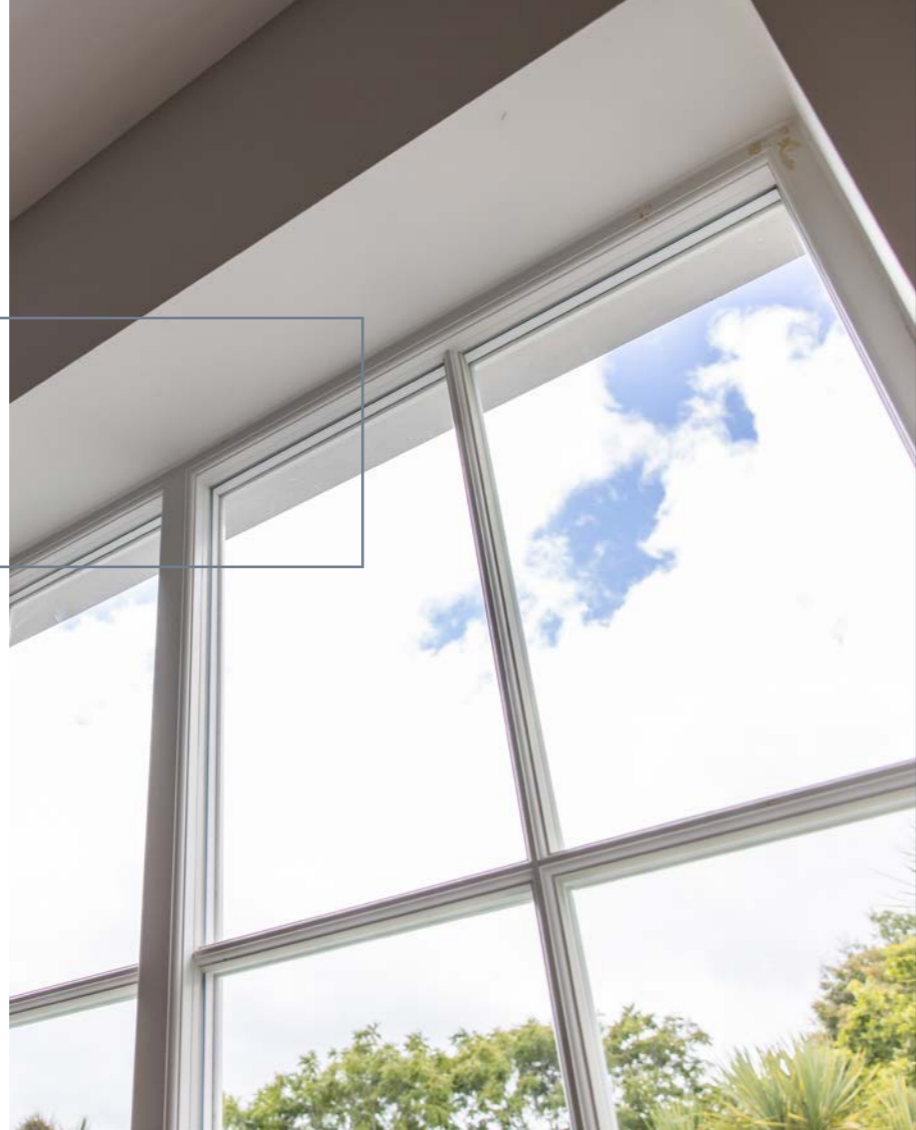

## Fixed Frame 90/115 mm

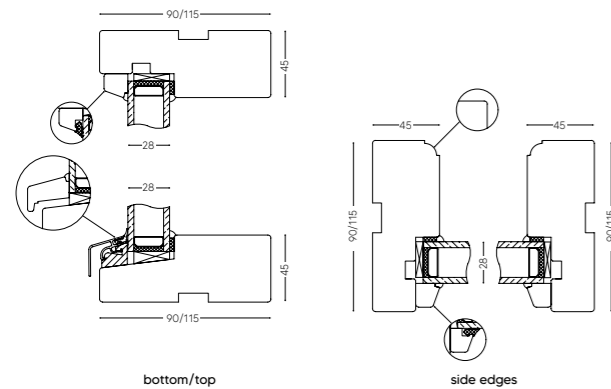

## Equipment of window

### Standard



Colors:  
7 - Aluminium  
8 - White  
9 - Brown

- Weight of construction up to 800kg
- Min.size of window 300x300mm
- Max.size of window 5000x5000mm (width x height)
- Attention! The shortest side of the construction max 2700mm
- Max. area of glass for one part 5.5m<sup>2</sup>



# DOORS

French Door | Entrance Door  
Brio Door | Sliding Door



# FRENCH DOOR



French doors are being loved for their functionality, aesthetic features, energy efficiency and many more advantages.



Create an entrance that is beautiful from both inside and outside your home.

French doors is used as entry doors and as interior doors that separate two spaces. Interior French doors is often found in the entryway between a dining room and kitchen/living room, also often used as backyard doors.

## French Door 90/115 frame

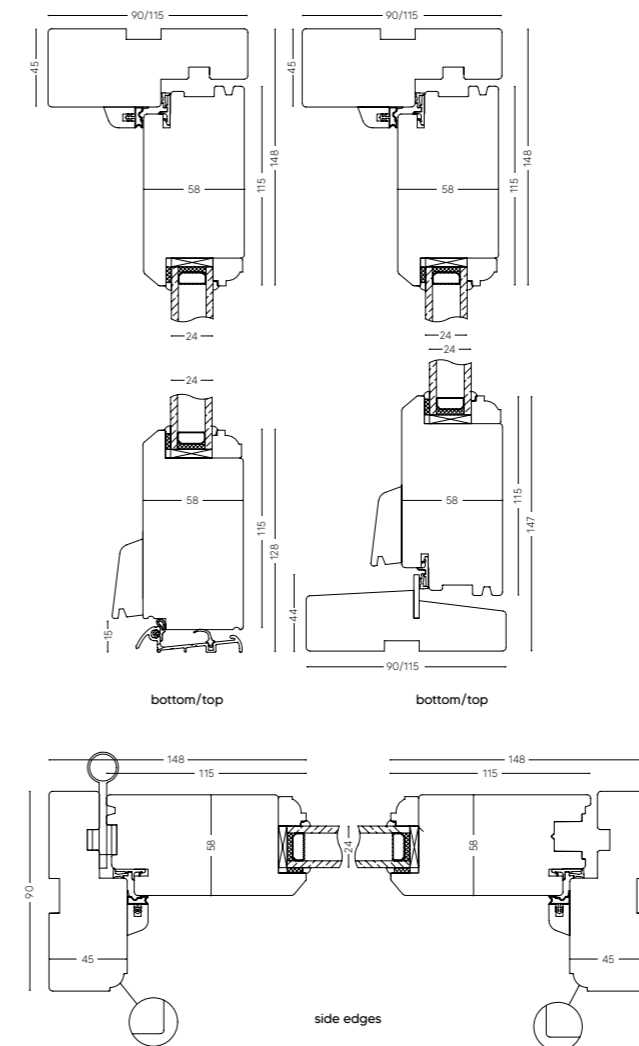

- Visible hinges (in door sides)
- Sash weight up to 100kg
- Min. door size 500x1750mm
- Max. door size 1100x2295 mm

## Equipment of doors

### Standard

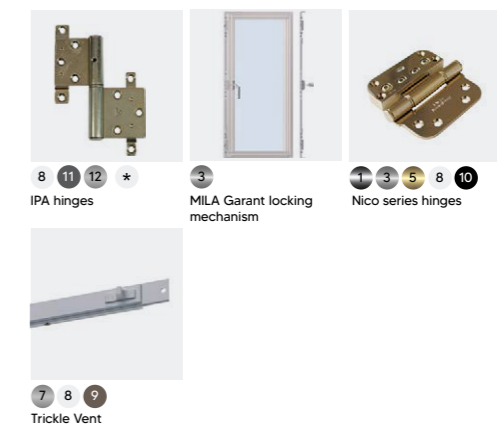

### Additional

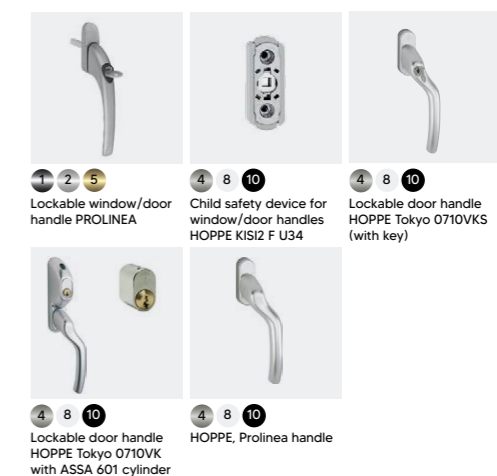

- Colors:
- 1 - Polished Chrome
  - 2 - Satin Chrome
  - 3 - Matt Chrome
  - 4 - Smokey Chrome
  - 5 - Polished Brass
  - 7 - Aluminium
  - 8 - White
  - 9 - Brown
  - 10 - Black
  - 11 - Grey
  - 12 - Steel
  - \* - custom RAL color



# ENTRANCE DOOR



Entrance doors is designed and produced in the best hardwood to create a spectacular entrance to your home. Your main entrance has to say welcome to your guests but resist unwanted visitors and protect against the bad weather.

Our casement entrance doors have many features, functions as well as design considerations. Our experienced engineers can provide a lot of useful information and help in making these important entrance and design decisions.

Langvalda entrance doors has optimised thermal insulation, good soundproofing and protection against burglary, a long service life as well as an appealing design.



## Entrance doors 90/115 mm frame

### Inside opening frame

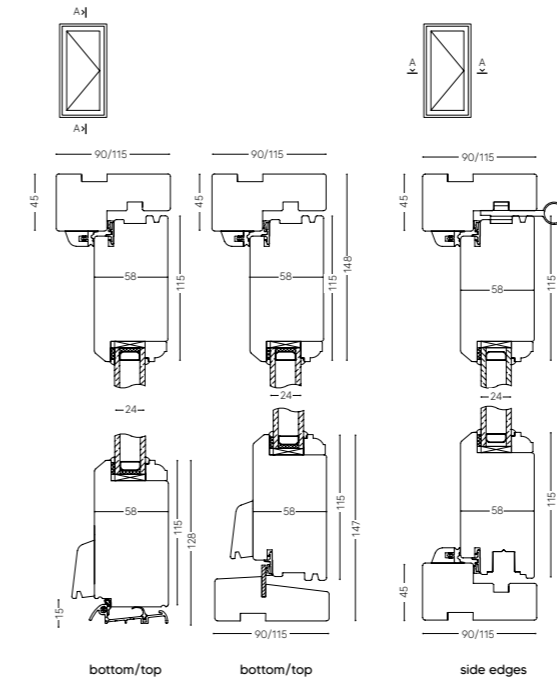

### Outside opening frame

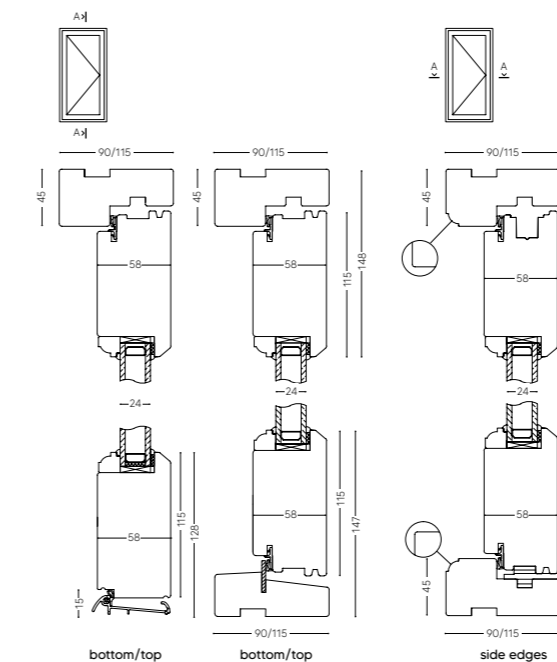

## Equipment of doors

### Standard

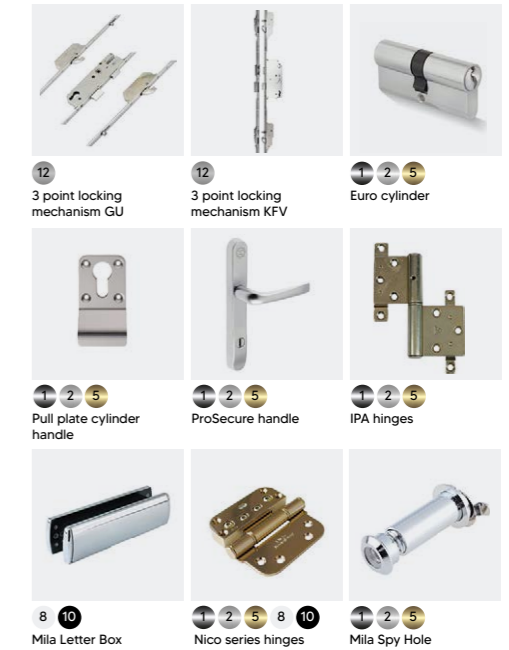

### Additional



Colors:  
 1 - Polished Chrome  
 2 - Satin Chrome  
 3 - Matt Chrome  
 5 - Polished Brass  
 7 - Aluminium  
 8 - White  
 9 - Brown  
 10 - Black  
 12 - Steel

- Visible hinges (door sides) (in door sides)
- Sash weight up to 100kg
- Min. door size 500x1750mm
- Max. door size 1100 x2295mm



# BRIO DOOR



If You want to have more open space, bring the light to your home, enhance view then these Bi-folding doors are what You are looking for.



Brio doors are made to fulfill all Your expectations. It can be used to replace your existing french or patio doors to create large patio onto terrace or patio area. Our Bi-fold doors are made from sustainably sourced hardwood, they are built to last a lifetime. Doors glide effortlessly on their durable tracks and fold neatly to one side creating maximum access to the outside.

## Brio Door frame

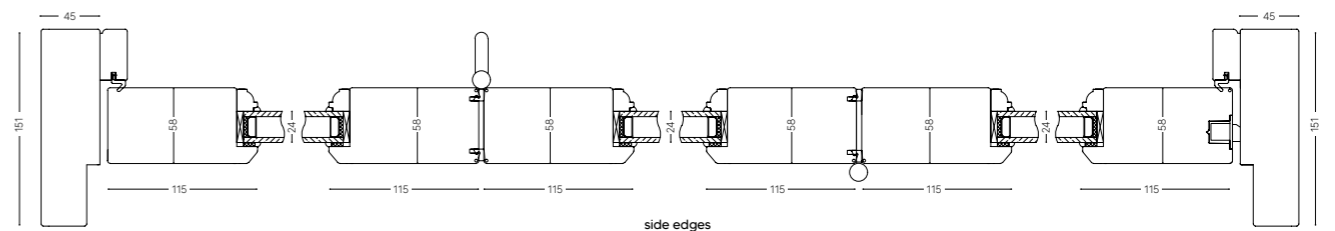
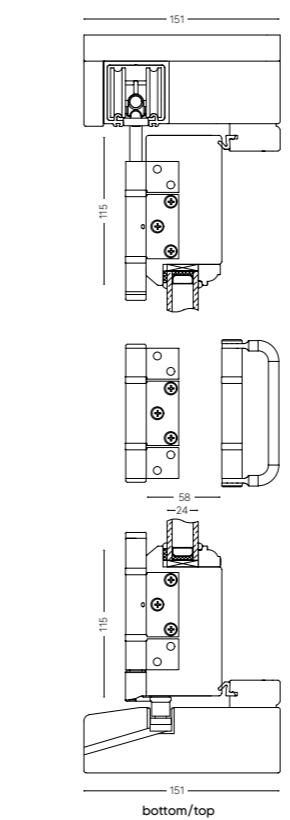

- Visible hinges
- Min. panel height 1750mm
- Min. panel width 550mm
- Sash weight max 100kg
- Max. panel height 3300mm
- Max. panel width 1000mm

## Equipment of doors

### Standard

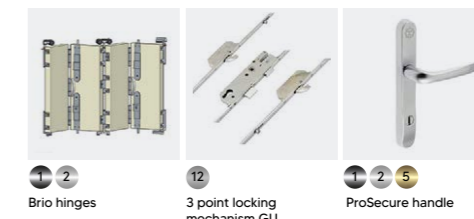

Colors:  
 1 - Polished Chrome  
 2 - Satin Chrome  
 5 - Polished Brass  
 12 - Steel

## Brio Door opening types

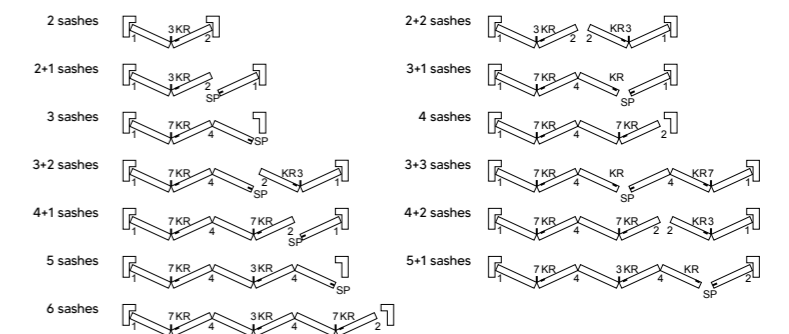



# SLIDING DOOR



Lift and slide door system is a popular choice for opening up large areas. A system lifts the panel off the sill enabling movement of large, heavy panels with very little effort.



## BENEFITS:

- Easy to open, even if the doors are huge and heavy. It doesn't affect the lightness of opening.
- Let the light come in to the room
- Opening space
- Resistant to air and water infiltration
- Motorized operation available
- Non-corroive, high quality hardware

Our lift and slide doors are made by combining many years of experience, traditions and new technologies. Our production team has more than 10 years experience in the manufacture of wooden windows. It helps us to maintain very high quality and constantly improve our products. It can be made with any wood and color You wish, any size and hardware style You need.

## Sliding Door frame

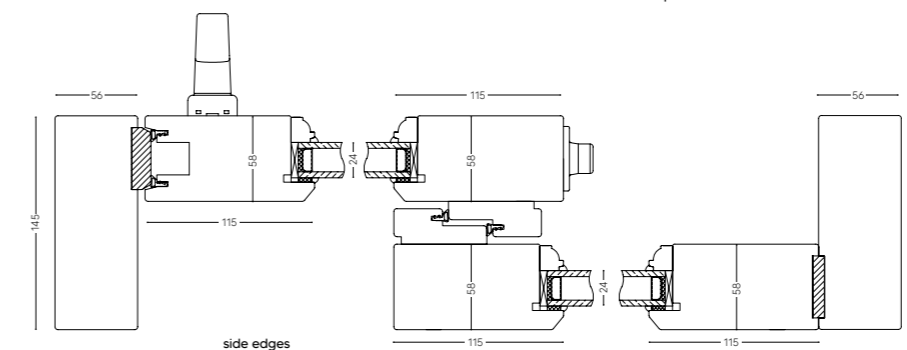
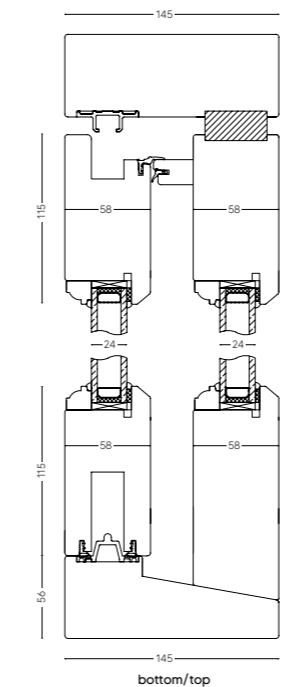

## Equipment of doors

### Standard

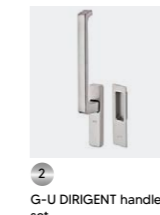
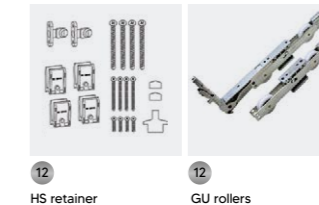

### Additional



Colors:  
2 - Satin Chrome  
4 - Smokey Chrome  
8 - White  
12 - Steel

- Sash weight up to 400kg
- Sash width 800-2500mm
- Sash height 1000-2800mm



## PACKAGING



With the packaging, we convey the message to our customers that when they buy “Langvalda” products, they are not only buying high-quality windows and doors, but also contributing to an important mission - replanting forests (we plant a tree for every product purchased).

 Langvalda

**We won't give up on quality**

- > high quality products
- > technical know-how
- > client focused partner
- > certified products
- > unusual ideas

info@langvalda.it | www.langvalda.co.uk

**THANK YOU FOR BUYING!**  
We planted a tree in exchange.  
We are glad you care about environment as much as we do



You can visit your tree here << Langvalda

In order to ensure the quality of our products until they are delivered to the customer, we have developed packaging that protects the products during transportation. In addition to the main protective function, the packaging also provides an opportunity to communicate more widely about the values of the “Langvalda” company and spread the idea of sustainability: it is clearly visible during transportation and already at the construction site at the customer’s place.

The qr code on the package invites you to visit “Langvalda” website and learn more about the ongoing sustainability project. In this way, the packaging helps us not only to spread the idea of sustainability, but also to create a more sustainable relationship with our customers.



## WARRANTY

- **Timber frame and sash frame against rot and fungal attack - 30 years**
- **Insulating glass units - 5 years**
- **Door locks and door hinges - 25 000 cycle**
- **Window hardware - 10 year**
- **Gaskets - 5 years**
- **Paint Finish guarantee against paint coating system failure - 10 years**
- **Turbo balances - 10 years**
- **2 year guarantee on electrical components**





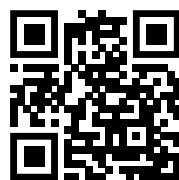

## LITHUANIA | Factory

UAB "LANGVALDA"  
Popieriaus str. 15  
LT-08404, Vilnius, Lithuania  
+37067976786  
info@langvalda.lt

 **Langvalda**