



Highest quality engineered  
**TIMBER WINDOWS  
AND DOORS**



## PRODUCTION

---

Qualified engineers working in Langvalda can make different kinds of ideas come to life and create spectacular windows and doors in whatever design clients fancy. The innovative and modern production machines that came here from well-known manufacturers of equipment in Europe, enable this company to produce not only standard products but also fulfill complex non-standard projects and architects' visions.



# D LUX

Custom feel every step of the way

From development to installation

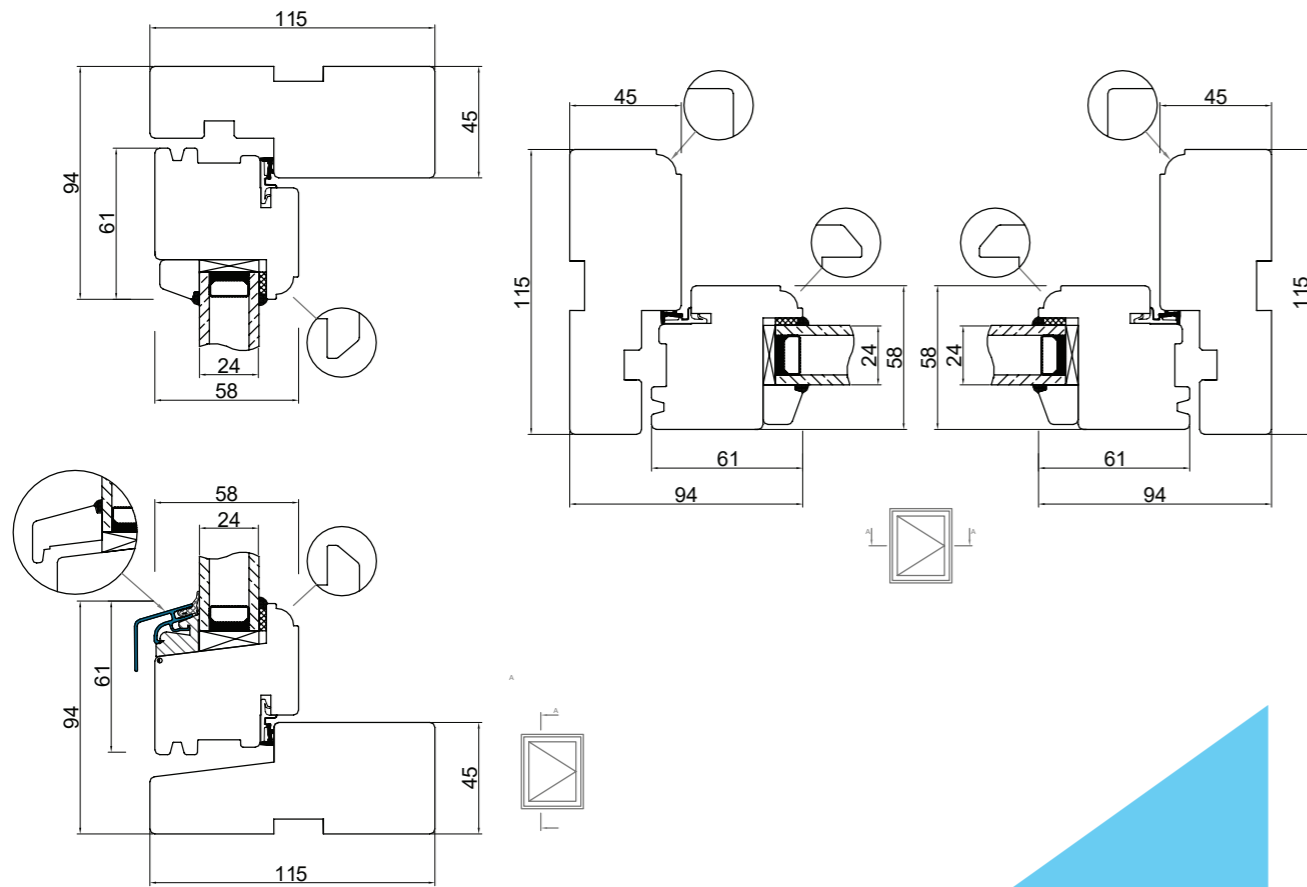

# IV78

Add a unique touch to your project

Our engineers will tailor window and door designs to meet your vision

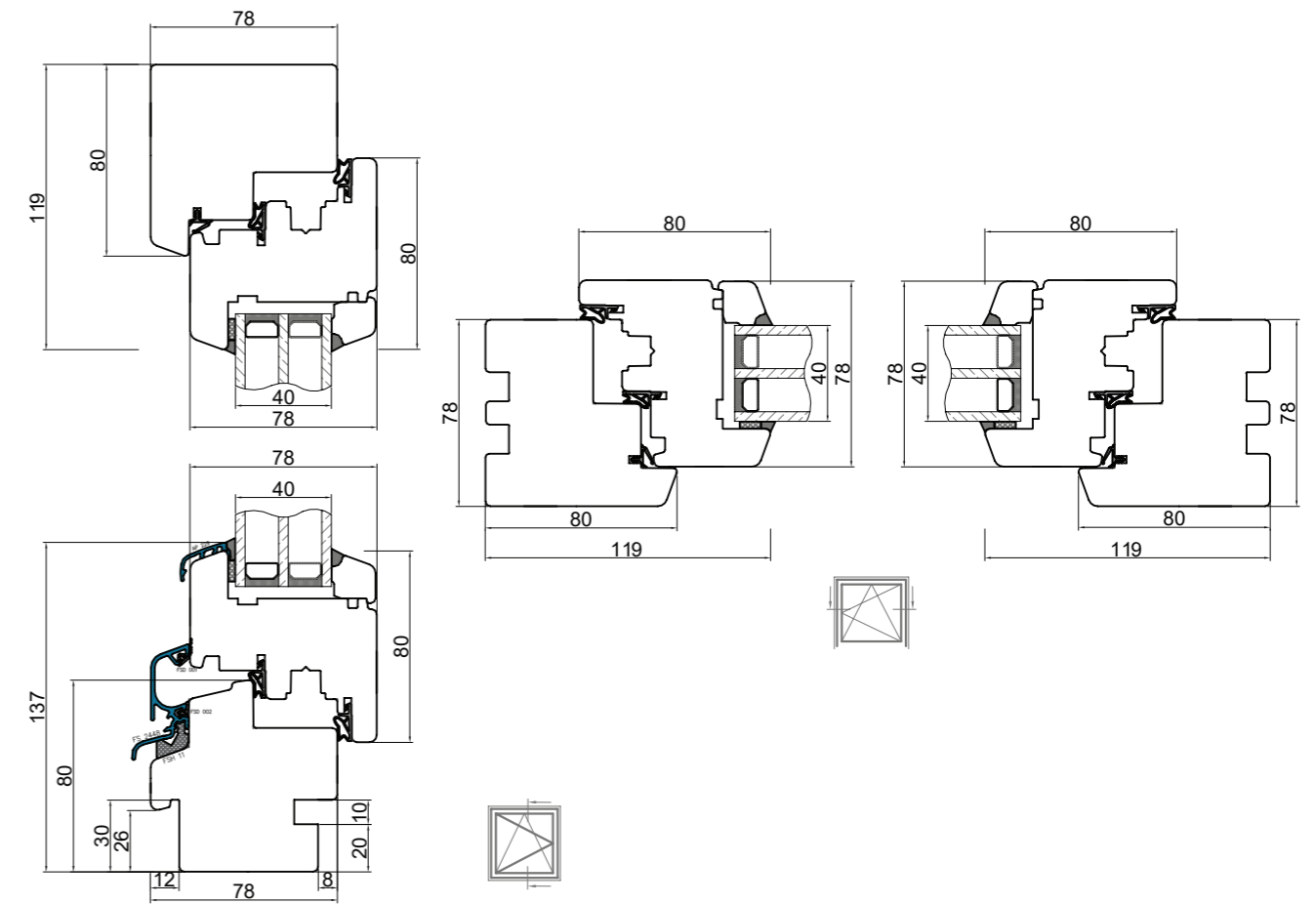

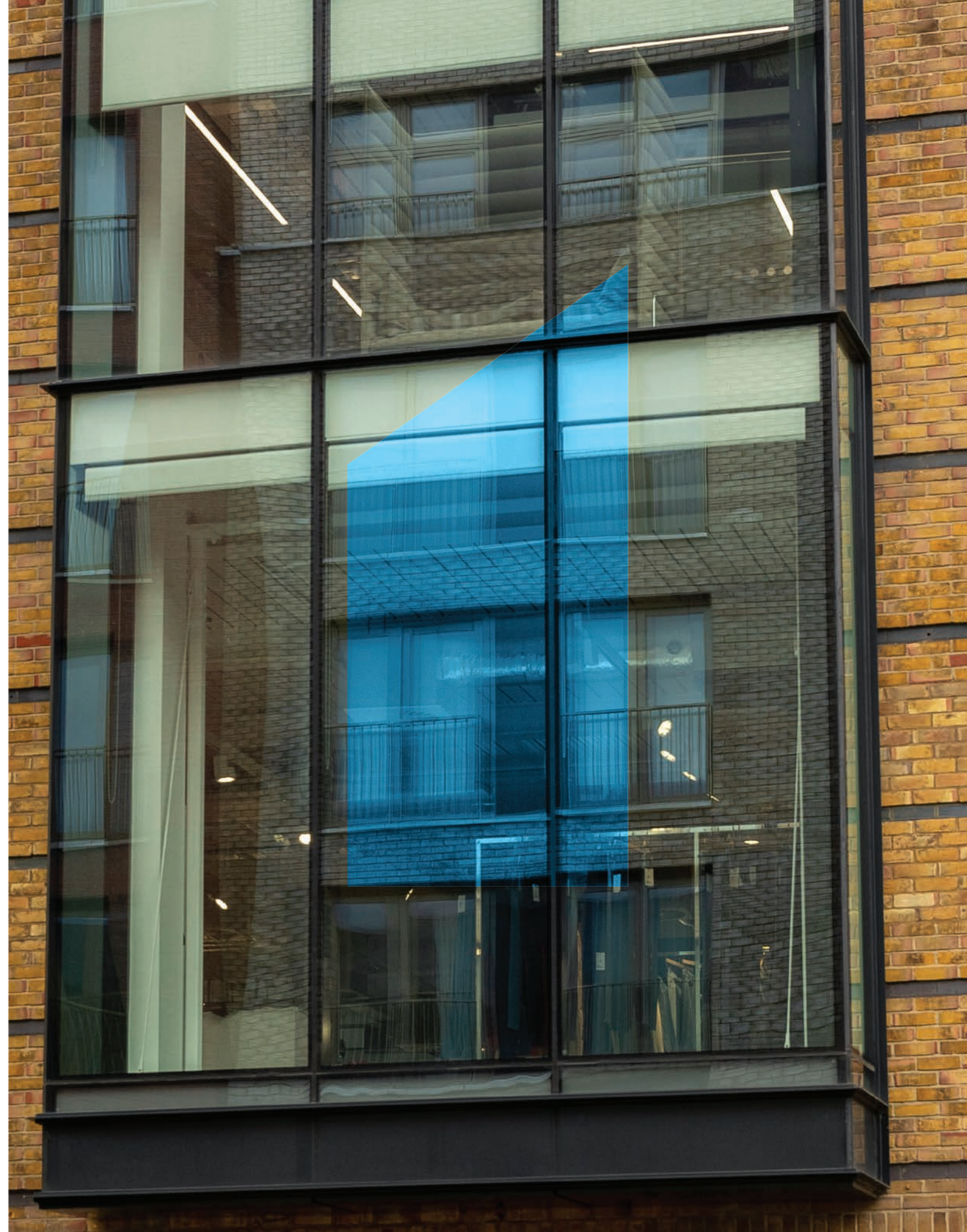

# IV92

Creative solutions  
for any project

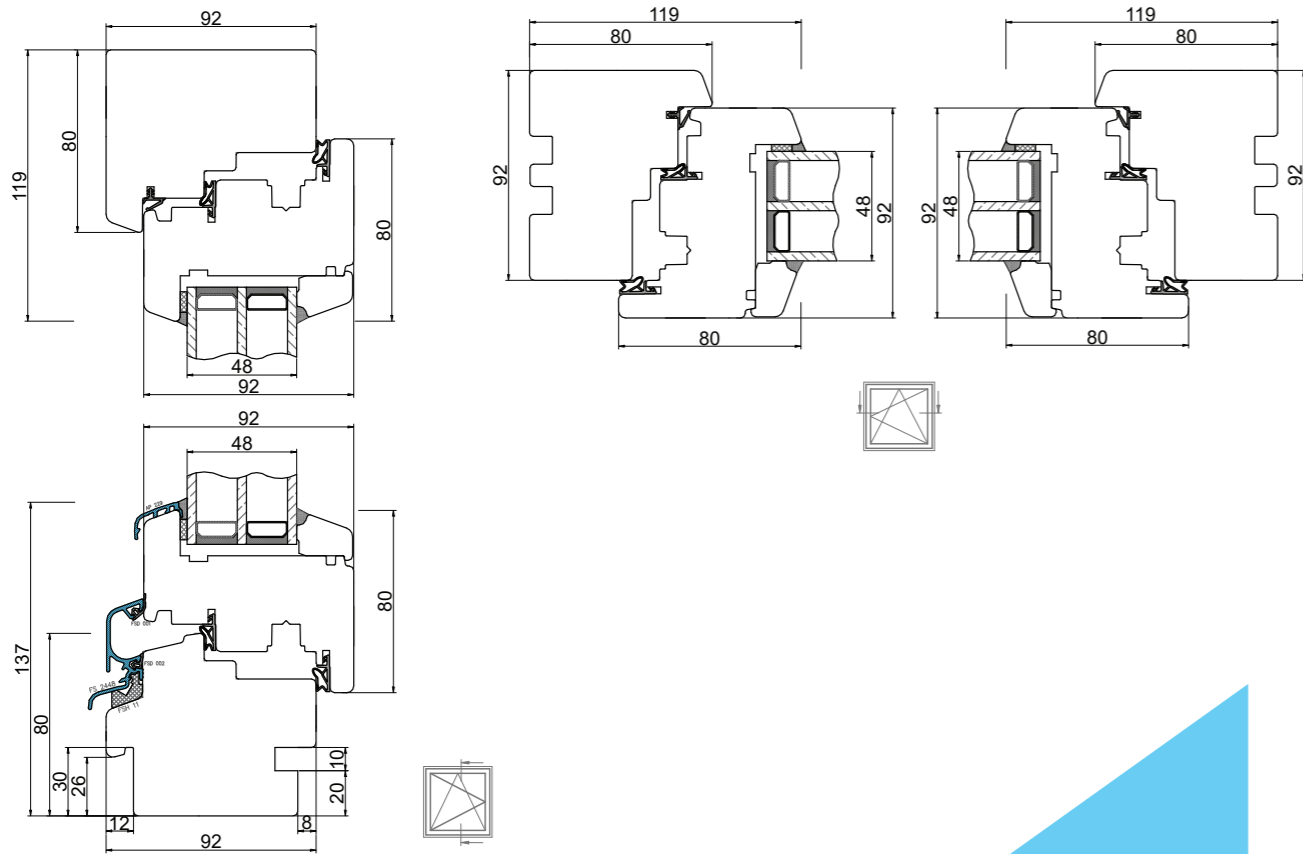

# NORD

Our engineers will  
tailor window and  
door designs to  
meet your vision

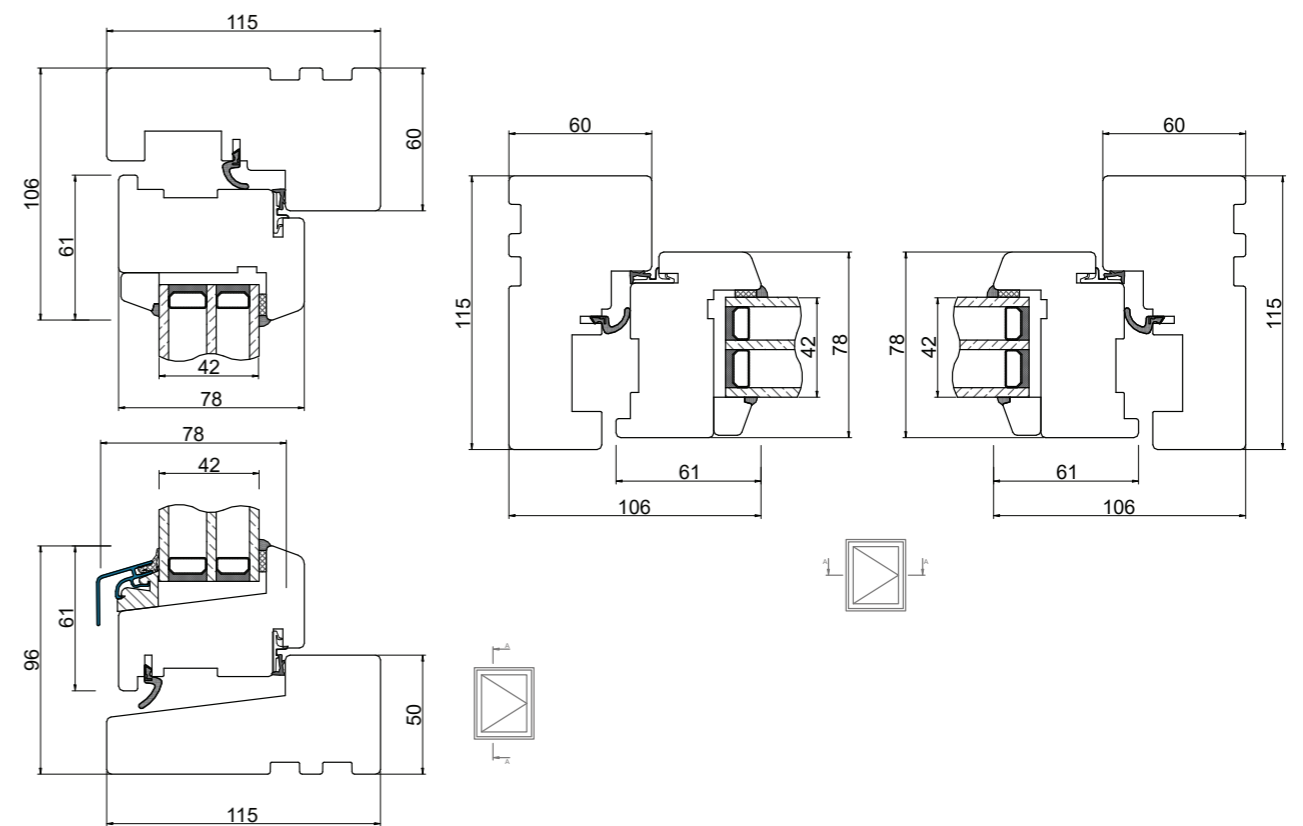



# LIFT&SLID

High quality timber structures

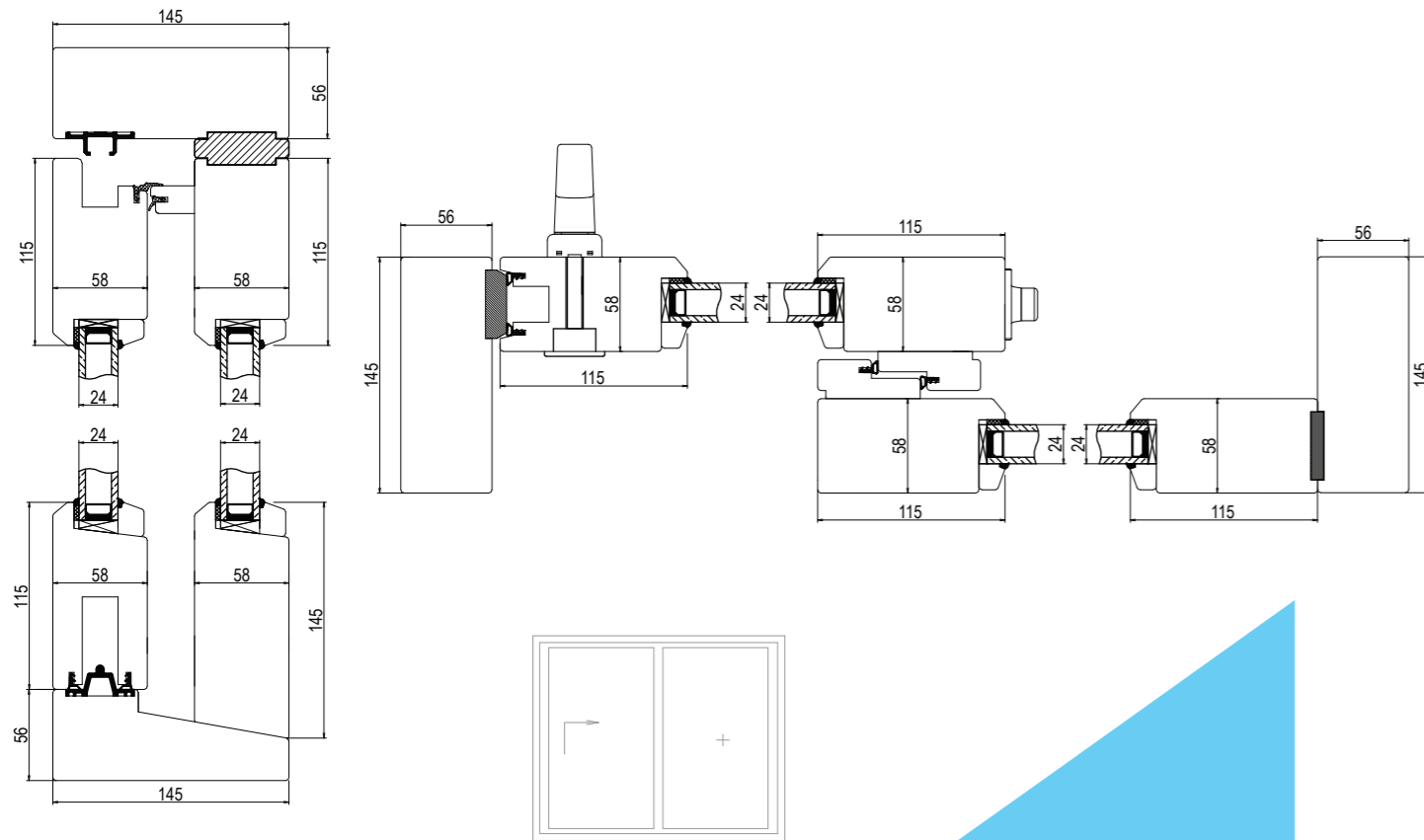

# SASH BOX

A sustainable take on timber

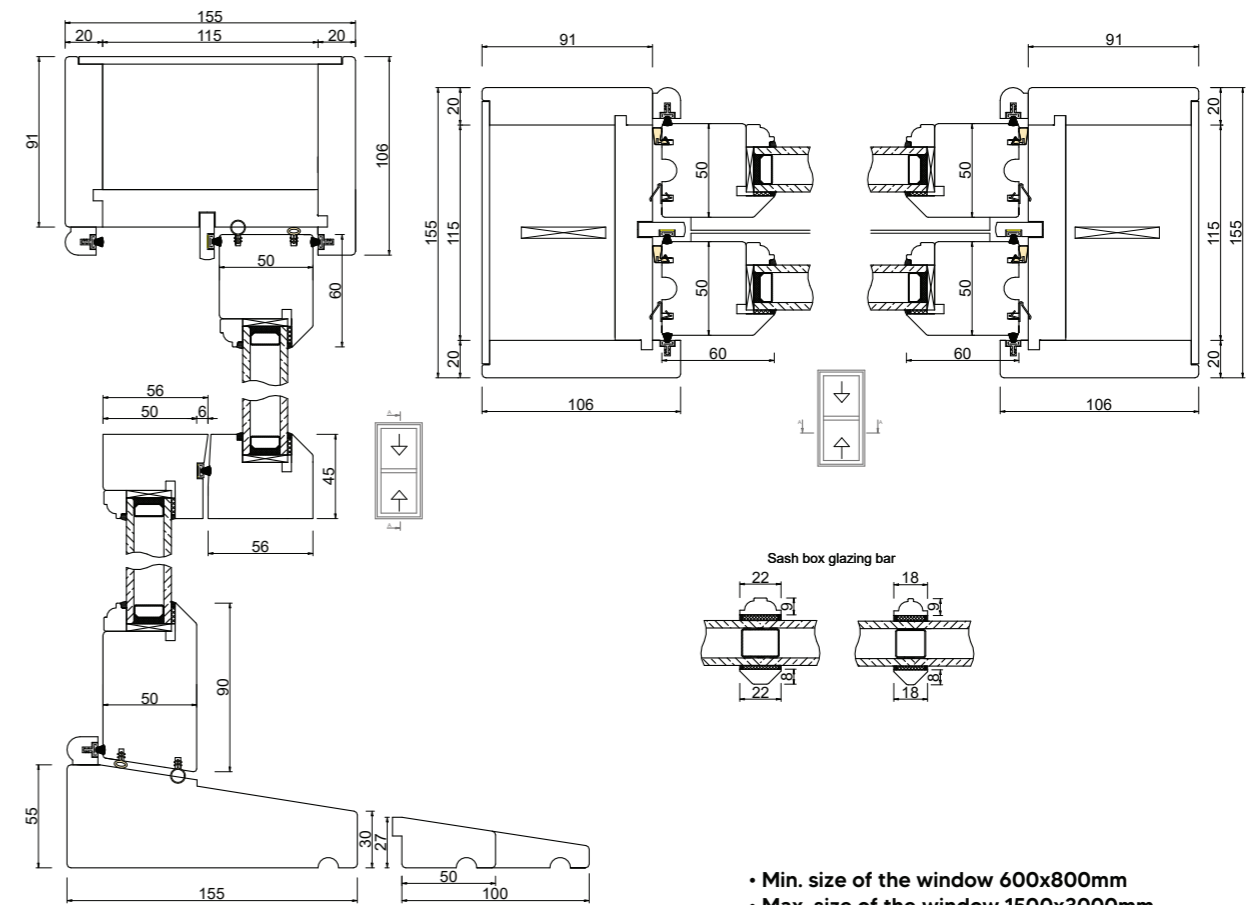

- Min. size of the window 600x800mm
- Max. size of the window 1500x3000mm





# SASH SPRING

Custom designs for any building

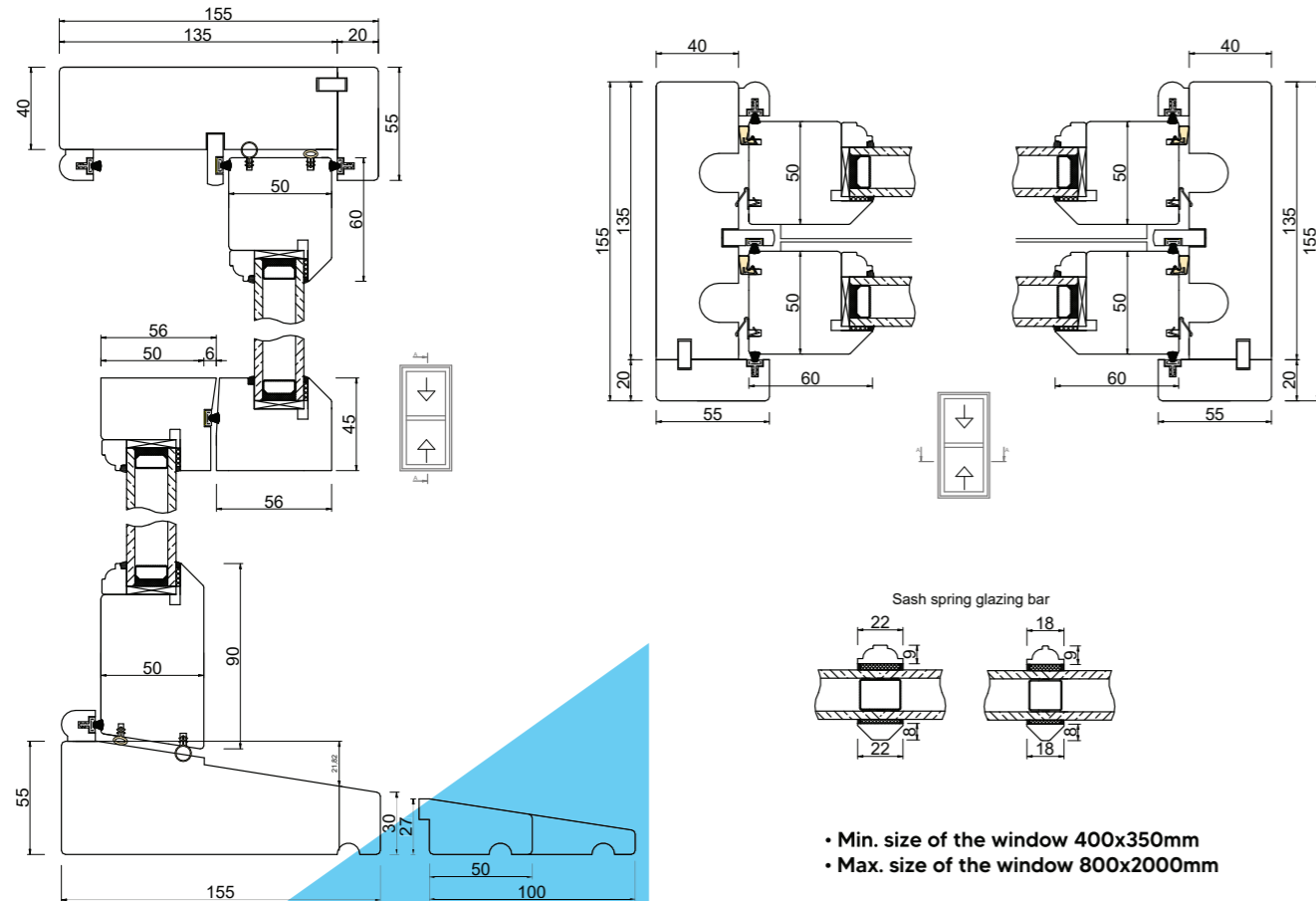

# BRIO DOORS

Any shape, any size, any color

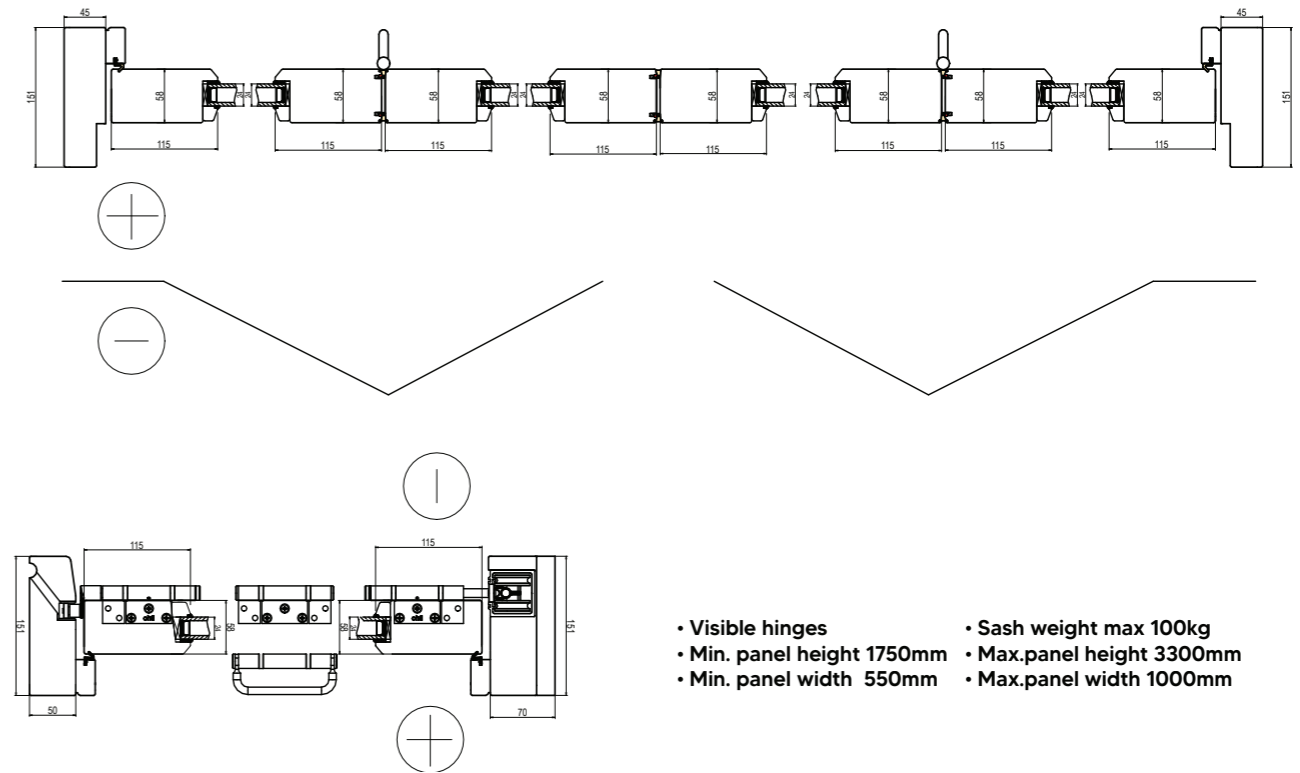

- Visible hinges
- Sash weight max 100kg
- Min. panel height 1750mm
- Max. panel height 3300mm
- Min. panel width 550mm
- Max. panel width 1000mm

# PACKAGING

In order to ensure the quality of our products until they are delivered to the customer, we have developed packaging that protects the products during transportation. In addition to the main protective function, the packaging also provides an opportunity to communicate more widely about the values of the “Langvalda” company and spread the idea of sustainability: it is clearly visible during transportation and already at the construction site at the customer’s place.

With the packaging, we convey the message to our customers that when they buy “Langvalda” products, they are not only buying high-quality windows and doors, but also contributing to an important mission - replanting forests (we plant a tree for every product purchased).

The qr code on the package invites you to visit “Langvalda” website and learn more about the ongoing sustainability project. In this way, the packaging helps us not only to spread the idea of sustainability, but also to create a more sustainable relationship with our customers.



**Langvalda**

**We won't give up on quality**

- > high quality products
- > technical know-how
- > client focused partner
- > certified products
- > unusual ideas

info@langvalda.it | www.langvalda.co.uk

**THANK YOU FOR BUYING!**  
We planted a tree in exchange.  
We are glad you care about environment as much as we do

You can visit your tree here <<  
Langvalda



## GUARANTEES

---

Timber frame and sash frame against rot and fungal attack - 30 years;

Insulating glass units - 5 years;

Door locks and door hinges - 25 000 cycle

Window hardware - 10 year;

Gaskets - 5 years;

Paint Finish guarantee against paint coating system failure - 10 years;

Turbo balances - 10 years

2 year guarantee on electrical components

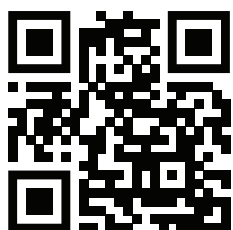

**LITHUANIA | Factory**

UAB "LANGVALDA"  
Popieriaus str. 15  
LT-08404, Vilnius, Lithuania  
+37067976786  
info@langvalda.lt